

K-12G



Socket (Coupling) Banded  
Reducing Weld

K-12H



Half Socket (Half Coupling)  
Weld O.D. Machined

K-12IN



Socket (Coupling) Weld Plain

K-12JN



Half Socket (Half Coupling)  
Weld Plain

K-12K



Hexagon Socket (Coupling)  
Plain

K-13



Hose Nipple Female

K-13A / K-013B



Union Conical Joint H/F  
Union Flat Seat With PTFE  
Gasket H/F

K-13C / K-13D



Union Conical Joint H/M  
Union Flat Seat With PTFE  
Gasket H/M

K-13E / K-13F



Union Conical Joint H/BW  
Union Flat Seat With PTFE  
Gasket H/BW

K-13G / K-13H



Union Conical Joint H/H  
Union Flat Seat With PTFE  
Gasket H/H

K-14 / K-14A



Union Elbow Conical Joint F/F  
Union Elbow Flat Seat With  
PTFE Gasket F/F

K-14B / K-14C



Union Elbow Conical Joint F/M  
Union Elbow Flat Seat With  
PTFE Gasket F/M

K-14D / K-14E



Union Elbow Conical Joint F/BW  
Union Elbow Flat Seat With  
PTFE Gasket F/BW

K-14F / K-14G



Union Elbow Conical Joint F/H  
Union Elbow Flat Seat With  
PTFE Gasket F/H

K-15



Double Compression Union

K-15A



Single Compression Union  
Male Thread

K-15B



Elbow 90 Compression Union

K-15C



Tee Compression Union

K-16



Welding Spud

K-17



Adaptor M/F

**K-14B** Union Elbow Conical Joint F/M

**K-14C** Union Elbow Flat Seat With PTFE Gasket F/M

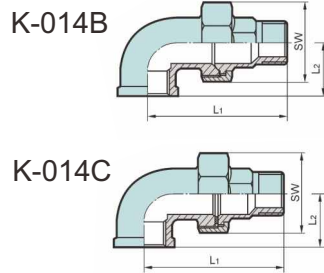

Unit: mm

SIZE	L <sub>1</sub>	L <sub>2</sub>	SW
1/8"	50.7	19.0	25.0
1/4"	58.6	21.0	30.0
3/8"	61.0	25.0	35.0
1/2"	71.0	28.0	42.0
3/4"	78.7	33.0	47.0
1"	88.4	38.0	53.0
1-1/4"	102.9	45.0	71.0
1-1/2"	110.3	50.0	78.0
2"	119.4	58.0	92.0

**K-14D** Union Elbow Conical Joint F/BW

**K-14E** Union Elbow Flat Seat With PTFE Gasket F/BW

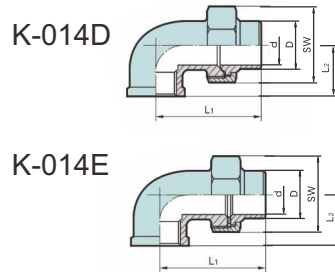

Unit: mm

SIZE	L <sub>1</sub>	L <sub>2</sub>	SW	D	d
1/8"	39.0	19.0	25.0	10.2	8.1
1/4"	46.2	21.0	30.0	13.5	10.0
3/8"	48.5	25.0	35.0	17.2	12.7
1/2"	54.6	28.0	42.0	21.3	16.7
3/4"	62.7	33.0	47.0	26.9	21.5
1"	68.0	38.0	53.0	33.7	26.5
1-1/4"	79.5	45.0	71.0	42.4	35.8
1-1/2"	88.0	50.0	78.0	48.3	42.0
2"	93.8	58.0	92.0	60.3	53.3

**K-14F** Union Elbow Conical Joint F/H

**K-14G** Union Elbow Flat Seat With PTFE Gasket F/H

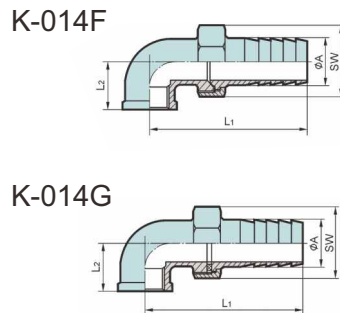

Unit: mm

SIZE	L <sub>1</sub>	L <sub>2</sub>	φA	SW
1/8"	52.0	19.0	6.5	25.0
1/4"	56.0	21.0	9.0	30.0
3/8"	67.0	25.0	11.0	35.0
1/2"	77.5	28.0	14.0	42.0
3/4"	82.0	33.0	20.5	47.0
1"	88.0	38.0	27.0	53.0
1-1/4"	101.7	45.0	33.0	71.0
1-1/2"	119.5	50.0	39.5	78.0
2"	130.4	58.0	52.0	92.0

**K-15** Double Compression Union

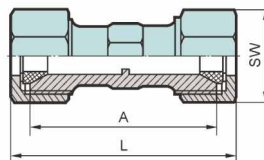

Unit: mm

SIZE (φD)		A	L	SW	
1/8"	12	1/4"	50.0	70.0	32.0
15	3/8"	18	50.0	70.0	36.0
20	1/2"	22	54.0	75.0	42.0
25	3/4"	28	62.0	80.0	50.0
30	1"	35	67.0	85.0	60.0
38.1	42	1-1/4"	70.0	85.0	69.0
44.5		1-1/2"	70.0	90.0	78.0
50.8		54.0	80.0	100.0	81.0
2"		63.5	80.0	100.0	92.0

### K-15A Single Compression Union Male Thread

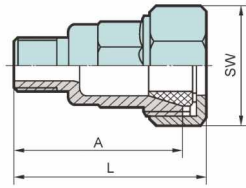

Unit: mm

SIZE (φD)			A	L	SW
12	1/8"		35.5	45.5	32.0
	1/4"		38.5	48.5	32.0
15	3/8"	18	39.0	49.0	36.0
20	1/2"	22	45.0	55.5	42.0
25	3/4"	28	50.5	59.5	50.0
30	1"	35	55.0	64.0	60.0
38.1	1-1/4"		60.0	68.0	69.0
44.5	1-1/2"		60.0	70.0	77.0
50.8	2"		65.0	75.0	81.0
2"		63.5	69.0	79.0	92.0

### K-15B Elbow 90 Compression Union

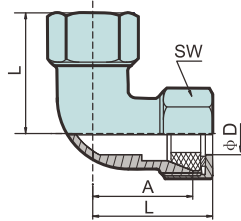

Unit: mm

SIZE (φD)				A	L	SW
10.0	12.0	13.5	14.0	35.5	45.0	32.0
15.0	16.0	17.2	18.0	36.5	46.0	36.0
20.0	21.3	22.0		40.5	50.5	42.0
25.0	26.9	28.0		45.5	54.0	50.0
30.0	33.7	35.0		51.0	60.0	60.0
38.0	42.0	42.4		56.0	63.5	69.0
44.5	48.3			60.5	70.0	77.0
50.8	54.0			62.5	72.0	81.0
60.3	63.5			68.5	78.0	92.0

### K-15C Tee Compression Union

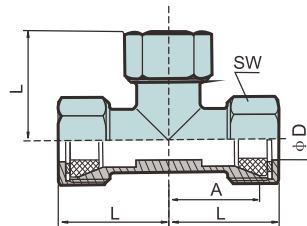

Unit: mm

SIZE (φD)				A	L	SW
10.0	12.0	13.5	14.0	35.5	45.0	32.0
15.0	16.0	17.2	18.0	36.5	46.0	36.0
20.0	21.3	22.0		40.5	50.5	42.0
25.0	26.9	28.0		45.5	54.0	50.0
30.0	33.7	35.0		51.0	60.0	60.0
38.0	42.0	42.4		56.0	63.5	69.0
44.5	48.3			60.5	70.0	77.0
50.8	54.0			62.5	72.0	81.0
60.3	63.5			68.5	78.0	92.0

### K-16 Welding Spud

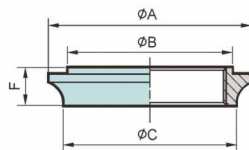

Unit: mm

SIZE	φA	φB	φC	F
1/8"	34.7	21.0	17.8	12.0
1/4"	37.5	24.6	20.1	13.5
3/8"	40.8	24.7	23.2	13.0
1/2"	44.5	28.8	27.9	14.9
3/4"	48.5	33.8	33.0	16.9
1"	56.6	42.9	42.0	19.7
1-1/4"	65.6	49.1	51.9	19.0
1-1/2"	71.5	55.5	56.5	20.1
2"	86.0	68.0	71.0	22.0
2-1/2"	98.6	79.8	81.7	24.8
3"	114.4	93.2	97.0	24.0
4"	143.5	119.0	124.5	26.7

### K-17 Adaptor M/F

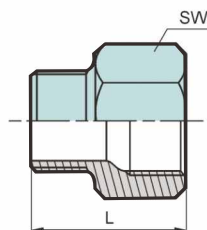

Unit: mm

SIZE	L	SW
1/8"	26.0	15.0
1/4"	28.5	17.0
3/8"	31.0	21.0
1/2"	37.5	26.0
3/4"	41.0	32.0
1"	46.0	38.0
1-1/4"	49.0	50.0
1-1/2"	51.0	54.0
2"	57.0	68.0